

① TOP CHANNELS

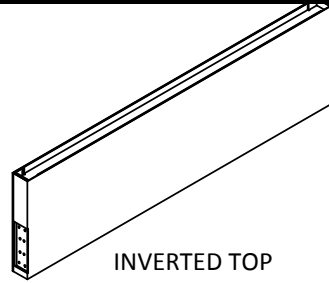

② CLOSER REINFORCEMENT

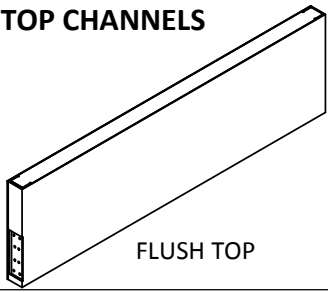
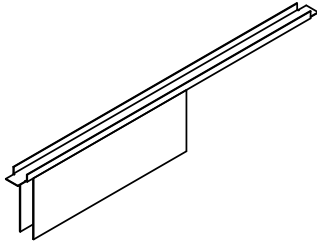

③ VERTICAL EDGE

STANDARD



NVS



④ HINGE PREP

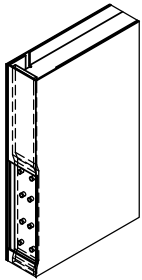

⑤ CORE

POLYURTHANE

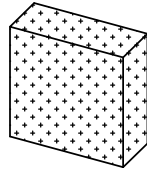

⑥ LOCK EDGE

BEVELED EDGE



SQUARE EDGE



⑦ LOCK PREP

FOR LOCK PREPS
SEE DOOR PREP PAGE

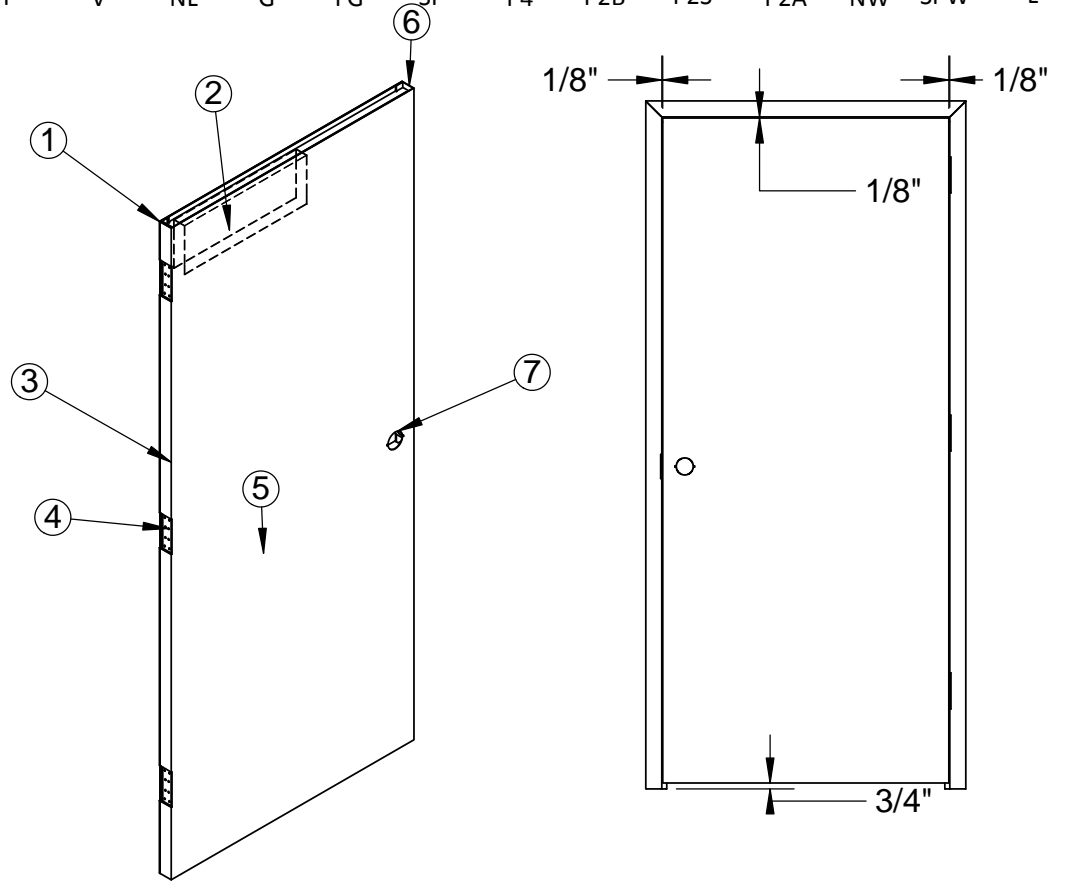
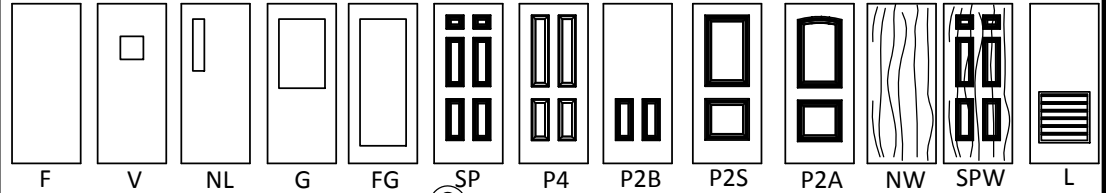

NU SERIES DOOR

DOOR MEETS OR EXCEEDS ANSI 250.4 PERFORMANCE TEST:

20 GAUGE STEEL (500,000 CYCLES)

18 & 16 GAUGE STEEL (1,000,000 CYCLES)

DOORS MEET LEED REQUIREMENTS AND BUY AMERICAN STANDARDS.

AVAILABLE IN:
14, 16, 18, 20
GAUGE
CR, A60



SUB-XX

DRAWN BY _____ DATE _____		ISSUE DATE	REVISIONS	BY
CHECKED _____ DATE _____				
SHT OF	JOB NO.			