

**① TOP CHANNELS**

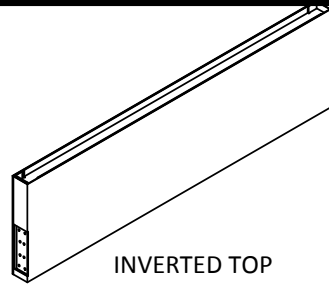

**② CLOSER REINFORCEMENT**

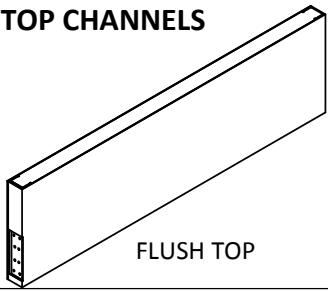
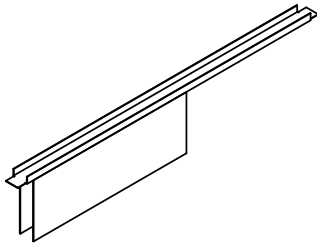

**③ VERTICAL EDGE**

STANDARD



NVS



**④ HINGE PREP**

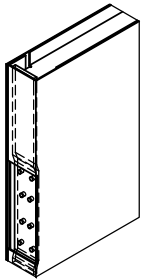

**⑤ CORE**

POLYSTRENE

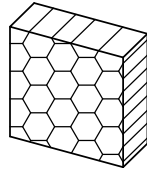

**⑥ LOCK EDGE**

BEVELED EDGE



SQUARE EDGE



**⑦ LOCK PREP**

FOR LOCK PREPS  
SEE DOOR PREP PAGE

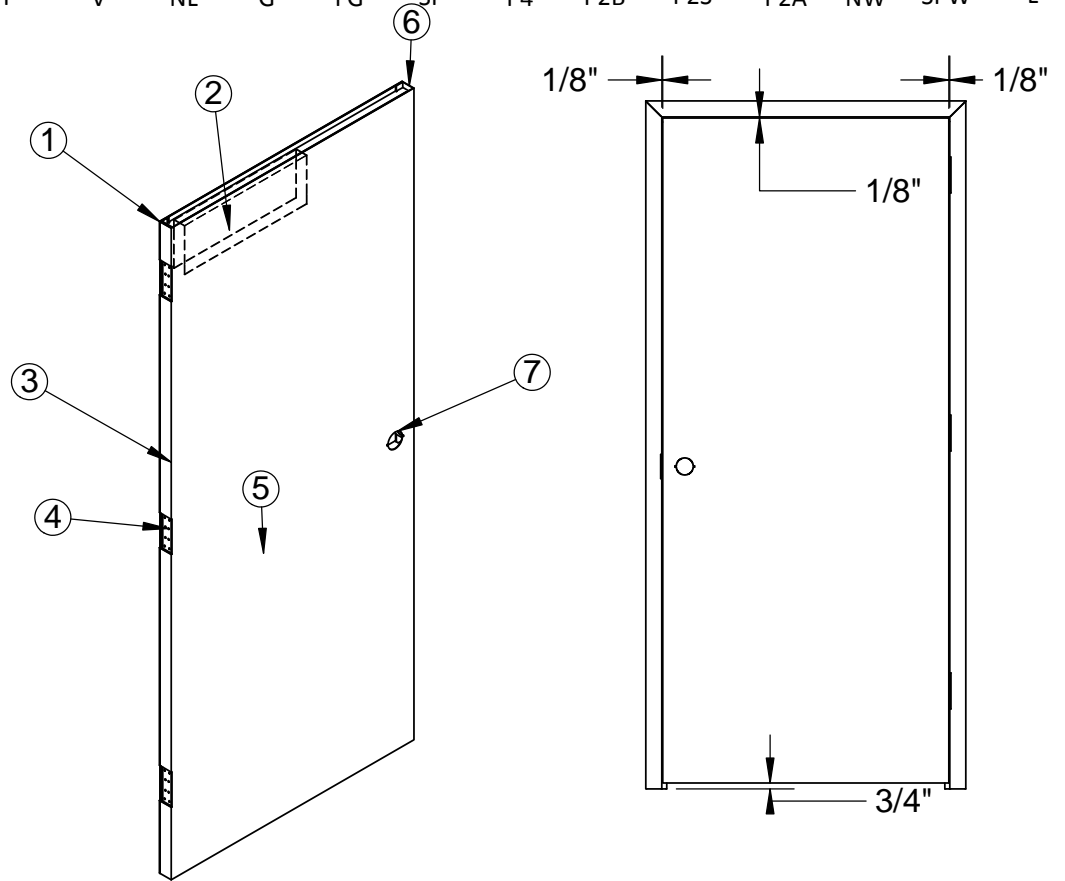
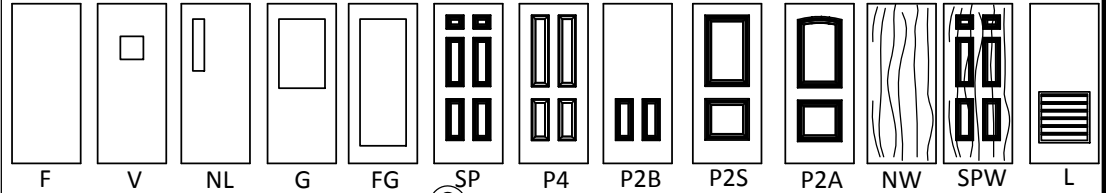

**NH SERIES DOOR**

DOOR MEETS OR EXCEEDS ANSI 250.4 PERFORMANCE TEST:

20 GAUGE STEEL (500,000 CYCLES)

18 & 16 GAUGE STEEL (1,000,000 CYCLES)

DOORS MEET LEED REQUIREMENTS AND BUY AMERICAN STANDARDS.

LABELING AGENCIES:  
UNDERWRITES LABRATORY INC.  
WARNOCK HERSEY INTL.  
FACTORY MUTUAL SYSTEM

AVAILABLE IN:  
14, 16, 18, 20  
GAUGE  
CR, A60



SUB-XX

DRAWN BY _____ DATE _____		ISSUE DATE	REVISIONS	BY
CHECKED _____ DATE _____				
SHT OF	JOB NO.			