

PROFILES

DOUBLE RABBET

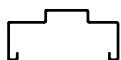

SINGLE RABBET



CASED OPEN

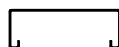

DOUBLE EGRESS



HOSPITAL STOP

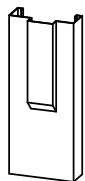

WELD OPTIONS

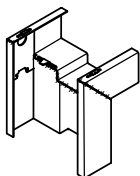

FULL WELD

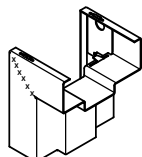

FACE WELD

CORNER SECTION

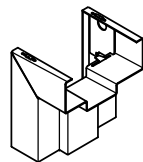
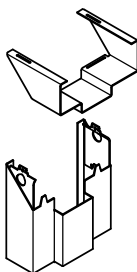

FDJ ANCHORING

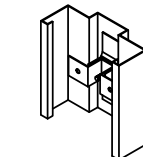

COMPRESSION ANCHOR

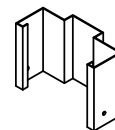

BASE ANCHOR DIMPLES

HINGE SPACING

OPENING HEIGHT	6'8"			7'0"			7'2"			7'10"			8'0"		
DIMENSION	A	B	C	A	B	C	A	B	C	A	B	C	A	B	C
1 3/4" DOOR SPACING	7 1/4"	2@ 30 1/4"	12 1/4"	7 1/4"	2@ 32 1/4"	12 1/4"	7 1/4"	2@ 33 1/4"	12 1/4"	7 1/4"	3@ 25 1/4"	10 1/4"	7 1/4"	3@ 25 1/2"	12 1/4"
1 3/8" DOOR SPACING				6 3/4"	2@ 32 3/4"	11 3/4"	6 3/4"	2@ 33 3/4"	11 3/4"						

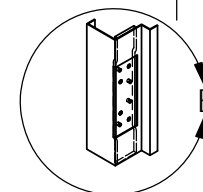
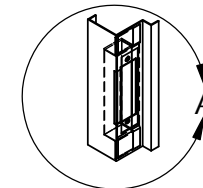
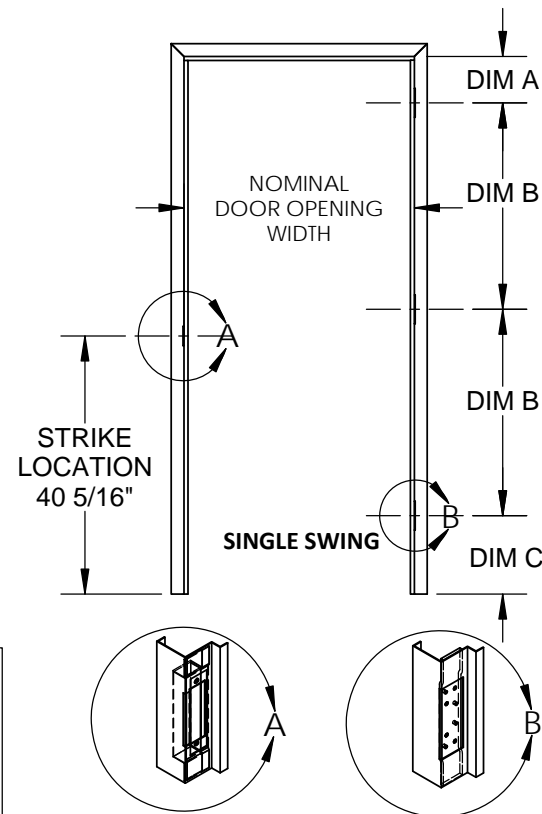
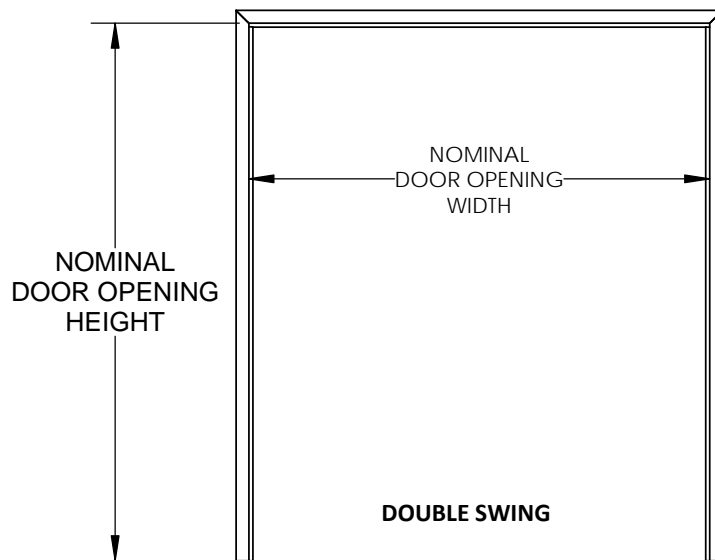

FDJ SERIES FRAMES

FDJ SERIES FRAMES ARE AVAILABLE AS SHOWN FOR THREE SIDED FRAMES OR AS STICK SECTIONS FOR TRANSOMS, SIDELIGHTS AND BORROWED LITE FRAMES.

FOR LABELING DETAILS, ANCHORING OPTIONS, AND DOOR HANDING & SWING, PLEASE SEE THE APPLICABLE SECTION OF THE TECHNICAL DATA MANUAL.



SUB-XX

DRAWN BY _____ DATE _____		ISSUE DATE	REVISIONS	BY
CHECKED _____ DATE _____				
SHT OF	JOB NO.			